

# COTTER / DOWEL PINS / RIVETS WOODRUFF KEYS / RETAINING RINGS

THIS DOCUMENT IS PROTECTED BY COPYRIGHT. ALL RIGHTS ARE RESERVED. NO PART OF THIS DOCUMENT MAY BE PHOTOCOPIED, REPRODUCED, OR TRANSLATED TO ANOTHER LANGUAGE WITHOUT THE WRITTEN CONSENT OF ARROW INDUSTRIAL SUPPLY, INC. THE INFORMATION CONTAINED IN THIS DOCUMENT IS SUBJECT TO CHANGE WITHOUT NOTICE. COPYRIGHT 1993.

<b>DOWEL PINS</b>				<b>COTTER PINS</b>			
1/16 DIA.		1/4 DIA.		7/16 DIA.		3/4 DIA.	
LNG	PART NUMBER	LNG	PART NUMBER	LNG	PART NUMBER	LNG	PART NUMBER
3/16	0007002850	1/2	0007003190	1	0007003610	1	0007003980
1/4	0007002860	5/8	0007003200	1-1/4	0007003620	2	0007004000
5/16	0007002870	3/4	0007003210	1-1/2	0007003630	2-1/2	0007004010
3/8	0007002880	7/8	0007003220	1-3/4	0007003640	3	0007004020
7/16	0007002890	1	0007003230	2	0007003650	3-1/2	0007004030
1/2	0007002900	1-1/8	0007003232	2-1/4	0007003660	4	0007004040
5/8	0007002910	1-1/4	0007003240	2-1/2	0007003670	4-1/2	0007004050
3/4	0007002920	1-1/2	0007003260	2-3/4	0007003680	5	0007004060
7/8	0007002930	1-3/4	0007003270	3	0007003690	6	0007004070
1	0007002940	2	0007003280				
		2-1/4	0007003290				
		2-1/2	0007003300				
3/32 DIA.		5/16 DIA.		1/2 DIA.		7/8 DIA.	
LNG	PART NUMBER	LNG	PART NUMBER	LNG	PART NUMBER	LNG	PART NUMBER
3/16	0007004210	1/2	0007003320	1/2	0007003695	2	0007004080
1/4	0007004220	5/8	0007003330	3/4	0007003700	2-1/2	0007004090
5/16	0007004230	3/4	0007003340	1	0007003710	3	0007004100
7/16	0007004240	7/8	0007003350	1-1/4	0007003720	4	0007004110
1/2	0007004250	1	0007003360	1-1/2	0007003730	6	0007004120
5/8	0007004260	1-1/4	0007003380	1-3/4	0007003740		
3/4	0007004270	1-1/2	0007003400	2	0007003750	1" DIA.	
7/8	0007004280	1-3/4	0007003410	2-1/4	0007003760	LNG	PART NUMBER
1	0007004290	2	0007003420	2-1/2	0007003770	2	0007004130
1-1/4	0007004291	2-1/4	0007003430	2-3/4	0007003780	2-1/2	0007004140
		2-1/2	0007003440	3	0007003790	3	0007004150
		3	0007003450	3-1/4	0007003800	3-1/2	0007004160
				3-1/2	0007003810	4	0007004170
				3-3/4	0007003820	4-1/2	0007004180
				4	0007003830	5	0007004190
				4-1/2	0007003835	6	0007004200
1/8 DIA.		3/8 DIA.		5/8 DIA.			
LNG	PART NUMBER	LNG	PART NUMBER	LNG	PART NUMBER		
1/8	0007002947	1/2	0007003470	1	0007003840		
1/4	0007002948	5/8	0007003480	1-1/4	0007003850		
3/8	0007002950	3/4	0007003490	1-1/2	0007003860		
1/2	0007002960	7/8	0007003500	1-3/4	0007003870		
5/8	0007002970	1	0007003510	2	0007003880		
3/4	0007002980	1-1/4	0007003520	2-1/4	0007003890		
7/8	0007002990	1-1/2	0007003540	2-1/2	0007003900		
1	0007003000	1-3/4	0007003550	3	0007003910		
1-1/4	0007003020	2	0007003560	3-1/2	0007003930		
1-1/2	0007003040	2-1/4	0007003570	4	0007003940		
1-3/4	0007003050	2-1/2	0007003580	4-1/2	0007003950		
2	0007003060	3	0007003600	5	0007003960		
3/16 DIA.							
LNG	PART NUMBER						
3/8	0007003065						
1/2	0007003070						
5/8	0007003080						
3/4	0007003090						
7/8	0007003100						
1	0007003110						
1-1/4	0007003130						
1-1/2	0007003150						
1-3/4	0007003160						
2	0007003170						
2-3/4	0007003180						

<b>COTTER PINS</b>					
1/16 DIA.		3/16 DIA.		5/16 DIA.	
LNG	PART NUMBER	LNG	PART NUMBER	LNG	PART NUMBER
1/2	0007000010	3/4	0007000210	1	0007000460
3/4	0007000020	1	0007000220	1-1/4	0007000470
1	0007000030	1-1/4	0007000230	1-1/2	0007000480
1-1/4	0007000040	1-1/2	0007000240	1-3/4	0007000490
1-1/2	0007000050	1-3/4	0007000250	2	0007000500
1-3/4	0007000060	2	0007000260	2-1/4	0007000510
2	0007000070	2-1/4	0007000270	2-1/2	0007000520
		2-1/2	0007000280	3	0007000530
		3	0007000290	3-1/2	0007000540
		3-1/2	0007000300	4	0007000550
		4	0007000310	5	0007000570
3/32 DIA.		1/4 DIA.		3/8 DIA.	
LNG	PART NUMBER	LNG	PART NUMBER	LNG	PART NUMBER
1/2	0007001260	1	0007000330	1-1/2	0007000600
3/4	0007001270	1-1/4	0007000340	2	0007000610
1	0007001280	1-1/2	0007000350	2-1/2	0007000630
1-1/4	0007001290	1-3/4	0007000360	3	0007000640
1-1/2	0007001300	2	0007000370	3-1/2	0007000650
1-3/4	0007001310	2-1/4	0007000380	4	0007000660
2	0007001320	2-1/2	0007000390	5	0007000670
2-1/4	0007001325	3	0007000400	6	0007000680
2-1/2	0007001340	3-1/2	0007000410		
		4	0007000420	1/2 DIA.	
				LNG	PART NUMBER
				2	0007001400



  

<b>HAIRPIN COTTERS</b>					
Hairpin cotter pins are reusable pins that can be inserted and removed quickly					
WIRE DIA.	INNER DIA.	TOTAL LNG	PART NUMBER		
3/4	.032	3/32	15/32	0007006100	
1	.062	3/16	1	0007006110	
1-1/4	.062	1/8	11/16	0007006120	
1-1/2	.047	1/8	7/8	0007006130	
1-3/4	.035	1/8	1/2	0007006140	
2	.046	3/16	15/16	0007006150	
2-1/4	.102	7/16	21/16	0007006160	
2-1/2	.028	1/19	1/2	0007006170	
3	.177	3/4	23/4	0007006180	
	.032	9/64	5/8	0007006190	
	.047	1/8	15/16	0007006200	
	.047	5/16	9/16	0007006210	
	.047	3/8	5/8	0007006220	
	5/32	3/4	2-1/2	0007006222	
	5/32	3/4	2-3/4	0007006221	
	1/4	1	4	0007006223	

LNG = LENGTH

# COTTER / DOWEL PINS / RIVETS WOODRUFF KEYS / RETAINING RINGS

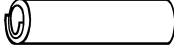
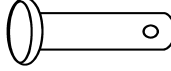
THIS DOCUMENT IS PROTECTED BY COPYRIGHT. ALL RIGHTS ARE RESERVED. NO PART OF THIS DOCUMENT MAY BE PHOTOCOPIED, REPRODUCED, OR TRANSLATED TO ANOTHER LANGUAGE WITHOUT THE WRITTEN CONSENT OF ARROW INDUSTRIAL SUPPLY, INC. THE INFORMATION CONTAINED IN THIS DOCUMENT IS SUBJECT TO CHANGE WITHOUT NOTICE. COPYRIGHT 1993.

<b>COILED SPIRAL PIN</b>			<b>CLEVIS PINS</b>			<b>"E" CLIPS</b>		
								
<b>1/16 DIA.</b>			<b>3/16 DIA.</b>			<b>DIAMETER</b>		
LNG	PART NUMBER		LNG	PART NUMBER		LNG	PART NUMBER	
5/16	0007005200		1/2	0007005430		1/16	0007005900	
3/4	0007005210		3/4	0007005440		3/32	0007005910	
<b>5/64 DIA.</b>			<b>5/16 DIA.</b>			<b>1/2 DIA.</b>		
LNG	PART NUMBER		LNG	PART NUMBER		LNG	PART NUMBER	
3/4	0007005220		1	0007005650		1-1/4	0007001532	
1	0007005230		1-1/4	0007005660		1-1/4	0007001533	
1-1/4	0007005240		1-1/4	0007005670		1-1/2	0007001534	
<b>3/32 DIA.</b>			<b>3/8 DIA.</b>			<b>5/8 DIA.</b>		
LNG	PART NUMBER		LNG	PART NUMBER		LNG	PART NUMBER	
5/8	0007005250		1-1/4	0007005720		1-1/2	0007001551	
3/4	0007005260		1-1/2	0007005730		2	0007001553	
1	0007005270		2	0007005740		1	0007006000	
1-1/4	0007005280		2-1/2	0007005750		5/8	0007006010	
1-1/2	0007005290		3	0007005760		3/4	0007006020	
<b>1/8 DIA.</b>			<b>7/16 DIA.</b>			<b>1/4 DIA.</b>		
LNG	PART NUMBER		LNG	PART NUMBER		LNG	PART NUMBER	
3/8	0007005300		2	0007005770		1	0007001509	
1/2	0007005310		2-1/2	0007005780		1*	0007001509-1	
3/4	0007005320		3	0007005790		1-1/4	0007001510	
1	0007005330		<b>1/2 DIA.</b>			1-1/2	0007001511	
1-1/2	0007005340		LNG	PART NUMBER		1-1/2*	0007001511-1	
1-3/4	0007005350		1-1/2	0007005800		1-3/4	0007001512	
2	0007005360		2	0007005810		2	0007001513	
<b>5/32 DIA.</b>			<b>3/8 DIA.</b>			<b>5/16 DIA.</b>		
LNG	PART NUMBER		LNG	PART NUMBER		LNG	PART NUMBER	
3/4	0007005370		1-1/2	0007005820		1	0007001517	
1	0007005380		2-1/2	0007005830		1-1/4	0007001518	
1-1/8	0007005390		<b>SQUARE KEYSTOCK</b>			<b>ZINC PLATING</b>		
1-1/4	0007005400					<b>12"</b>		
1-1/2	0007005410		SIZE	PART NUMBER	SIZE	PART NUMBER	SIZE	PART NUMBER
2	0007005420		1/8 X 1/8	0007006750	3/8 X 3/8	0007006790	5/8 X 5/8	0007006910
			1/8 X 3/8	0007006741	3/8 X 1/2	0007006795	3/4 X 3/4	0007006920
			1/8 X 3/16	0007006746	7/16 X 7/16	0007006800	7/8 X 7/8	0007006930
			18 X 1/4	0007006747	7/16 X 1/2	0007006745	1 X 1	0007006940
			3/16 X 3/16	0007006760	1/2 X 1/2	0007006900		
			1/4 X 1/4	0007006770	1/2 X 3/4	0007006743		
			1/4 X 3/8	0007006980	1/2 X 5/8	0007006744		
			1/4 X 1/2	0007006742	9/16 X 9/16	0007006905		
			5/16 X 5/16	0007006780	11/16 X 11/16	0007006908		

LNG = LENGTH

\*=STEEL

# COTTER / DOWEL PINS / RIVETS WOODRUFF KEYS / RETAINING RINGS

THIS DOCUMENT IS PROTECTED BY COPYRIGHT. ALL RIGHTS ARE RESERVED. NO PART OF THIS DOCUMENT MAY BE PHOTOCOPIED, REPRODUCED, OR TRANSLATED TO ANOTHER LANGUAGE WITHOUT THE WRITTEN CONSENT OF ARROW INDUSTRIAL SUPPLY, INC. THE INFORMATION CONTAINED IN THIS DOCUMENT IS SUBJECT TO CHANGE WITHOUT NOTICE. COPYRIGHT 1993.

## SPRING LOCK PINS

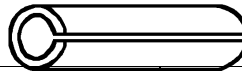

1/16 DIA.		1/8 DIA.		3/16 DIA.		1/4 DIA.		3/8 DIA.	
LNG	PART NUMBER	LNG	PART NUMBER	LNG	PART NUMBER	LNG	PART NUMBER	LNG	PART NUMBER
3/16	0007007000	1/4	0007007048	3/8	0007007088	1/2	0007007128	3/4	0007007171
1/4	0007007001	3/8	0007007049	1/2	0007007089	5/8	0007007129	1	0007007172
5/16	0007007002	7/16	0007007050	9/16	0007007090	11/16	0007007130	1-1/4	0007007173
3/8	0007007003	1/2	0007007051	5/8	0007007091	3/4	0007007131	1-1/2	0007007174
7/16	0007007004	9/16	0007007052	11/16	0007007092	13/16	0007007132	1-3/4	0007007175
1/2	0007007005	5/8	0007007053	3/4	0007007093	7/8	0007007133	2	0007007176
9/16	0007007006	11/16	0007007054	13/16	0007007094	15/16	0007007134	2-1/4	0007007177
5/8	0007007007	3/4	0007007055	7/8	0007007095	1	0007007135	2-1/2	0007007178
11/16	0007007008	13/16	0007007056	15/16	0007007096	1-1/8	0007007136	2-3/4	0007007179
3/4	0007007009	7/8	0007007057	1	0007007097	1-1/4	0007007137	3	0007007180
13/16	0007007010	15/16	0007007058	1-1/8	0007007098	1-1/4	0007007137	3-1/4	0007007181
7/8	0007007011	1	0007007059	1-1/4	0007007099	1-3/8	0007007138	3-1/2	0007007182
15/16	0007007012	1-1/4	0007007061	1-3/8	0007007100	1-1/2	0007007139	3-3/4	0007007183
1	0007007013	1-3/8	0007007062	1-1/2	0007007101	1-5/8	0007007140	4	0007007184
<b>5/64 DIA.</b>		1-1/2	0007007063	1-5/8	0007007102	1-3/4	0007007141	<b>7/16 DIA.</b>	
LNG	PART NUMBER	1-5/8	0007007064	1-3/4	0007007103	1-7/8	0007007142	LNG	PART NUMBER
3/16	0007007014	1-3/4	0007007065	1-7/8	0007007104	2	0007007143	1	0007007185
1/4	0007007015	1-7/8	0007007066	2	0007007105	2-1/4	0007007144	1-1/4	0007007186
5/16	0007007016	2	0007007067	2-1/2	0007007107	2-1/2	0007007145	1-1/2	0007007187
3/8	0007007017	<b>5/32 DIA.</b>		<b>7/32 DIA.</b>		2-3/4	0007007146	1-3/4	0007007188
7/16	0007007018	LNG	PART NUMBER	LNG	PART NUMBER	3	0007007147	2	0007007189
1/2	0007007019	7/16	0007007068	9/16	0007007108	3-1/4	0007007148	2-1/4	0007007190
9/16	0007007020	1/2	0007007069	11/16	0007007109	3-1/2	0007007149	2-1/2	0007007191
5/8	0007007021	9/16	0007007070	5/8	0007007110	<b>5/16 DIA.</b>		2-3/4	0007007192
11/16	0007007022	5/8	0007007071	13/16	0007007112	LNG	PART NUMBER	3	0007007193
3/4	0007007023	11/16	0007007072	7/8	0007007113	3/4	0007007150	3-1/4	0007007194
13/16	0007007024	13/16	0007007074	15/16	0007007114	13/16	0007007151	3-1/2	0007007195
7/8	0007007025	7/8	0007007075	1	0007007115	7/8	0007007152	3-3/4	0007007196
15/16	0007007026	15/16	0007007076	1-1/8	0007007116	15/16	0007007153	4	0007007197
1	0007007027	1	0007007077	1-1/4	0007007117	1	0007007154	<b>1/2 DIA.</b>	
1-1/8	0007007028	1-1/8	0007007078	1-3/8	0007007118	1-1/8	0007007155	LNG	PART NUMBER
1-1/4	0007007029	1-1/4	0007007079	1-1/2	0007007119	1-1/4	0007007156	1-1/4	0007007198
1-1/2	0007007030	1-3/8	0007007080	1-5/8	0007007120	1-3/8	0007007157	1-1/2	0007007199
<b>3/32 DIA.</b>		1-1/2	0007007081	1-3/4	0007007121	1-1/2	0007007158	1-3/4	0007007200
LNG	PART NUMBER	1-5/8	0007007082	1-7/8	0007007122	1-5/8	0007007159	2	0007007201
1/4	0007007031	1-3/4	0007007083	2	0007007123	1-3/4	0007007160	2	0007007202
5/16	0007007032	1-7/8	0007007084	2-1/4	0007007124	1-7/8	0007007161	2-1/4	0007007202
3/8	0007007033	2	0007007085	2-1/2	0007007125	2	0007007162	2-1/2	0007007203
7/16	0007007034	2-1/4	0007007086	2-3/4	0007007126	2-1/4	0007007163	2-3/4	0007007204
1/2	0007007035	2-1/2	0007007087	3	0007007127	2-1/2	0007007164	3	0007007205
9/16	0007007036					2-3/4	0007007165	3-1/4	0007007206
5/8	0007007037					3	0007007166	3-1/2	0007007207
11/16	0007007038					3-1/4	0007007167	3-3/4	0007007208
3/4	0007007039					3-1/2	0007007168	4	0007007209
13/16	0007007040					3-3/4	0007007169		
7/8	0007007041					4	0007007170		
15/16	0007007042								
1	0007007043								
1-1/4	0007007045								
1-3/8	0007007046								
1-1/2	0007007047								

## RETAINING RINGS

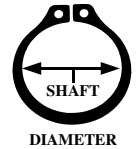

INTERNAL		EXTERNAL	
DIA.	PART NUMBER	DIA.	PART NUMBER
1/4	0007004500	1/8	0007004820
5/16	0007004510	3/16	0007004830
3/8	0007004520	1/4	0007004840
7/16	0007004530	5/16	0007004850
29/64	0007004540	3/8	0007004860
1/2	0007004550	13/32	0007004870
9/16	0007004560	7/16	0007004880
5/8	0007004570	15/32	0007004890
11/16	0007004580	1/2	0007004900
3/4	0007004590	9/16	0007004910
13/16	0007004600	19/32	0007004920
.777	0007004605	5/8	0007004930
7/8	0007004610	11/16	0007004940
.901	0007004615	3/4	0007004950
15/16	0007004620	25/32	0007004960
1	0007004630	13/16	0007004970
1-1/16	0007004640	7/8	0007004980
1-1/8	0007004650	15/16	0007004990
1-3/16	0007004660	63/64	0007004995
1-1/4	0007004670	1	0007005000
1-5/16	0007004680	1-1/16	0007005010
1-3/8	0007004690	1-1/8	0007005020
1-7/16	0007004700	1-3/16	0007005030
1-1/2	0007004710	1-1/4	0007005040
1-9/16	0007004720	1-5/16	0007005050
1-5/8	0007004730	1-3/8	0007005060
1-11/16	0007004740	1-7/16	0007005070
1-3/4	0007004750	1-1/2	0007005080
1-13/16	0007004760	1-9/16	0007005090
1-7/8	0007004770	1-5/8	0007005100
1-15/16	0007004780	1-3/4	0007005110
2	0007004790	1-11/16	0007005115
2-1/16	0007004800	1-13/16	0007005117
2-1/8	0007004810	1-7/8	0007005120
2-1/2	0007004814	2	0007005130
		2-5/8	0007005132
		3	0007005138

Retaining rings are precision-engineered components which, applied on shafts or in bores, provide a shoulder that accurately positions, locates or retains other parts of an assembly. The are used to replace pins and washers, threaded sections, collars, machine shoulders, and other costly and time-consuming methods. Retaining rings are available in thirty-nine different design series, to suit shaft/bore sizes from .039" to fifteen inches, and in a full range of metric sizes from 1mm to 400mm.

LNG = LENGTH

# COTTER / DOWEL PINS / RIVETS WOODRUFF KEYS / RETAINING RINGS

THIS DOCUMENT IS PROTECTED BY COPYRIGHT. ALL RIGHTS ARE RESERVED. NO PART OF THIS DOCUMENT MAY BE PHOTOCOPIED, REPRODUCED, OR TRANSLATED TO ANOTHER LANGUAGE WITHOUT THE WRITTEN CONSENT OF ARROW INDUSTRIAL SUPPLY, INC. THE INFORMATION CONTAINED IN THIS DOCUMENT IS SUBJECT TO CHANGE WITHOUT NOTICE. COPYRIGHT 1993.

## WOODRUFF KEYS SIZE CHART

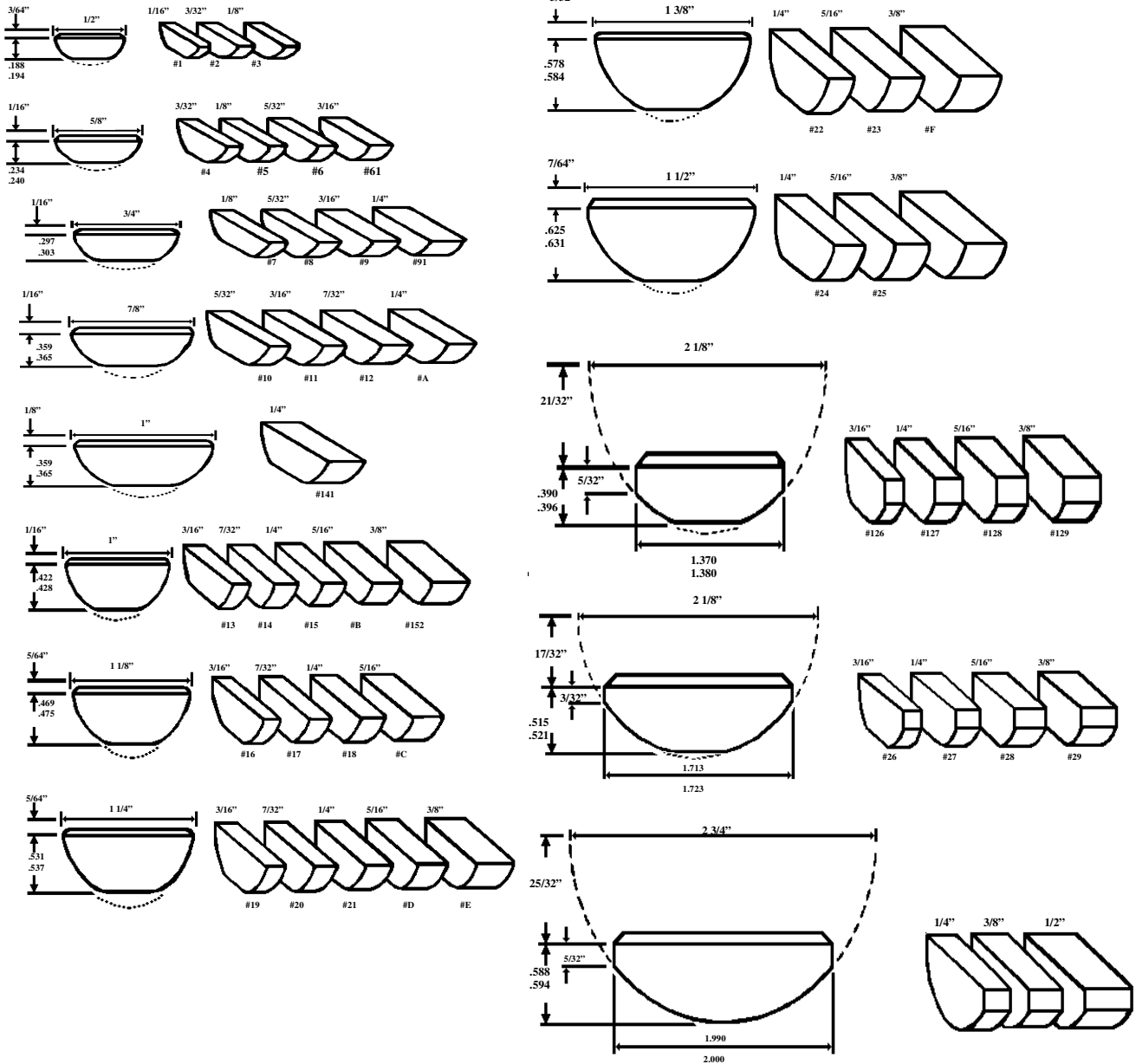

USA STD #	SIZE	PART NUMBER	USA STD #	SIZE	PART NUMBER	USA STD #	SIZE	PART NUMBER	USA STD #	SIZE	PART NUMBER
1	1/16 X 1/2	0007006290	8	5/32 X 3/4	0007006370	126	3/16 X 2-1/8	0007006450	21	1/4 X 1-1/4	0007006630
2	3/32 X 1/2	0007006300	10	5/32 X 7/8	0007006380	12	7/32 X 7/8	0007006560	22	1/4 X 1-3/8	0007006640
4	3/32 X 5/8	0007006310	61	3/16 X 5/8	0007006390	14	7/32 X 1	0007006570	24	1/4 X 1-1/2	0007006650
213	1/8 X 3/8	0007006320	9	3/16 X 3/4	0007006400	17	7/32 X 1-1/8	0007006580	B	5/16 X 1	0007006660
3	1/8 X 1/2	0007006330	11	3/16 X 7/8	0007006410	91	1/4 X 3/4	0007006590	C	5/16 X 1-1/8	0007006670
5	1/8 X 5/8	0007006340	13	3/16 X 1	0007006420	A	1/4 X 7/8	0007006600	D	5/16 X 1-1/4	0007006680
7	1/8 X 3/4	0007006350	16	3/16 X 1-1/8	0007006430	15	1/4 X 1	0007006610	23	5/16 X 1-3/8	0007006690
6	5/32 X 5/8	0007006360	19	3/16 X 1-1/4	0007006440	18	1/4 X 1-1/8	0007006620	E	3/8 X 1-1/4	0007006700
									F	3/8 X 1-3/8	0007006710

# COTTER / DOWEL PINS / RIVETS WOODRUFF KEYS / RETAINING RINGS

THIS DOCUMENT IS PROTECTED BY COPYRIGHT. ALL RIGHTS ARE RESERVED. NO PART OF THIS DOCUMENT MAY BE PHOTOCOPIED, REPRODUCED, OR TRANSLATED TO ANOTHER LANGUAGE WITHOUT THE WRITTEN CONSENT OF ARROW INDUSTRIAL SUPPLY, INC. THE INFORMATION CONTAINED IN THIS DOCUMENT IS SUBJECT TO CHANGE WITHOUT NOTICE. COPYRIGHT 1993.

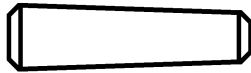

## TAPER PINS



7/0 1/16 DIA.		3/0 1/8 DIA.		#1 1/16 DIA.		#3 7/32 DIA.		#5 19/64 DIA.		#7 13/32 DIA.		#9 19/32 DIA.	
LNG	PART NUMBER	LNG	PART NUMBER	LNG	PART NUMBER	LNG	PART NUMBER	LNG	PART NUMBER	LNG	PART NUMBER	LNG	PART NUMBER
1/2	0077000105	1/2	0077000240	3/4	0077000445	3/4	0077000585	3/4	0077000785	1	0077001025	1	0077001275
3/4	0077000110	3/4	0077000245	1	0077000450	1	0077000590	1	0077000790	1-1/4	0077001030	1-1/4	0077001280
1	0077000115	1	0077000250	1-1/4	0077000455	1-1/4	0077000595	1-1/4	0077000795	1-1/2	0077001035	1-1/2	0077001285
1-1/4	0077000120	1-1/4	0077000255	1-1/2	0077000460	1-1/2	0077000600	1-1/2	0077000800	1-3/4	0077001040	1-3/4	0077001290
1-1/2	0077000125	1-1/2	0077000260	1-3/4	0077000465	1-3/4	0077000605	1-3/4	0077000805	2	0077001045	2	0077001295
<b>6/0 5/64 DIA.</b>		1-3/4	0077000265	2	0077000470	2	0077000610	2	0077000810	2-1/4	0077001050	2-1/4	0077001300
		2	0077000270	2-1/4	0077000475	2-1/4	0077000615	2-1/4	0077000815	2-1/2	0077001055	2-1/2	0077001305
<b>LNG PART NUMBER</b>		2-1/4	0077000275	2-1/2	0077000480	2-1/2	0077000620	2-1/2	0077000820	2-3/4	0077001060	2-3/4	0077001310
		2-1/2	0077000280	2-3/4	0077000485	2-3/4	0077000625	2-3/4	0077000825	3	0077001065	3	0077001315
1/2	0077000130	2-3/4	0077000285	3	0077000490	3	0077000630	3	0077000830	3-1/4	0077001070	3-1/4	0077001320
3/4	0077000135	3	0077000290	3-1/4	0077000495	3-1/4	0077000635	3-1/4	0077000835	3-1/2	0077001075	3-1/2	0077001325
1	0077000140	3-1/4	0077000295	3-1/2	0077000500	3-1/2	0077000640	3-1/2	0077000840	3-3/4	0077001080	3-3/4	0077001330
1-1/4	0077000145	<b>2/0 9/64 DIA.</b>		3-3/4	0077000505	3-3/4	0077000645	3-3/4	0077000845	4	0077001085	4	0077001335
1-1/2	0077000150			LNG PART NUMBER	4	0077000510	4	0077000650	4	0077000850	4-1/4	0077001090	4-1/4
<b>5/0 3/32 DIA.</b>		1/2	0077000300	<b>#2 3/16 DIA.</b>		4-1/4	0077000655	4-1/4	0077000855	4-1/2	0077001095	4-1/2	0077001345
		3/4	0077000305			LNG PART NUMBER	4-1/2	0077000660	4-1/2	0077000860	4-3/4	0077001100	4-3/4
1/2	0077000155	1-1/4	0077000315	3/4	0077000515	<b>#4 1/4 DIA.</b>		4-3/4	0077000865	5	0077001105	5	0077001355
3/4	0077000160	1-1/2	0077000320	1	0077000520			LNG PART NUMBER	5-1/4	0077000875	5-1/4	0077001110	5-1/4
1	0077000165	1-3/4	0077000325	1-1/4	0077000525	3/4	0077000675	5-1/2	0077000880	5-1/2	0077001115	5-1/2	0077001365
1-1/4	0077000170	2	0077000330	1-1/2	0077000530	1	0077000680	5-3/4	0077000885	5-3/4	0077001120	5-3/4	0077001370
1-1/2	0077000175	2-1/4	0077000335	2	0077000535	1-1/4	0077000685	6	0077000890	6	0077001125	6	0077001375
<b>4/0 7/64 DIA.</b>		2-1/2	0077000340	2	0077000540	1-1/2	0077000690	<b>#6 11/32 DIA.</b>		6-1/4	0077001130	6-1/4	0077001380
		2-	0077000345	2-1/4	0077000545	1-3/4	0077000695			LNG PART NUMBER	6-1/2	0077001135	6-1/2
1/2	0077000180	3/4	0077000350	2-1/2	0077000550	2	0077000700	3/4	0077000895	6-3/4	0077001140	6-3/4	0077001390
3/4	0077000185	3	0077000355	2-	0077000555	2-1/4	0077000705	1	0077000900	7	0077001145	7	0077001395
1	0077000190	3-1/4	0077000360	3/4	0077000560	1-1/2	0077000710	1-1/4	0077000905	<b>#8 1/2 DIA.</b>		<b>#10 23/32 DIA.</b>	
1-1/4	0077000200	<b>#0 5/32 DIA.</b>		3	0077000565	2-1/2	0077000715	1-1/2	0077000910				
1-1/2	0077000205			LNG PART NUMBER	3-1/4	0077000570	3	0077000720	2-1/2	0077000720	1	0077001150	1
1-3/4	0077000210	1/2	0077000370	3-1/2	0077000575	3-1/4	0077000725	1-3/4	0077000915	1-1/4	0077001155	1-1/4	0077001405
2	0077000215	3/4	0077000375	3-3/4	0077000580	3-1/2	0077000730	2	0077000920	1-1/2	0077001160	1-1/2	0077001410
2-1/4	0077000220	4	0077000380	<b>LNG = LENGTH</b>		4	0077000740	2-1/4	0077000925	1-3/4	0077001165	1-3/4	0077001415
2-1/2	0077000225	1	0077000385			4-1/4	0077000745	3-3/4	0077000735	2-1/2	0077000930	2	0077001170
2-3/4	0077000230	1-1/4	0077000385	4-1/2	0077000750	4-1/4	0077000745	2-3/4	0077000935	2-1/4	0077001175	2-1/4	0077001425
3	0077000235	1-1/2	0077000390	4-3/4	0077000755	4-1/2	0077000755	3	0077000940	2-1/2	0077001180	2-1/2	0077001430
<b>LNG PART NUMBER</b>		1-3/4	0077000395	5	0077000760	5	0077000760	3-1/4	0077000945	2-3/4	0077001185	2-3/4	0077001435
		2	0077000400	5-1/4	0077000765	5-1/4	0077000765	3-1/2	0077000950	3	0077001190	3	0077001440
2-1/4	0077000405	5-1/2	0077000770	5-1/2	0077000770	5-1/2	0077000770	3-3/4	0077000955	3-1/4	0077001195	3-1/4	0077001445
2-1/2	0077000410	5-3/4	0077000775	6	0077000780	6	0077000780	4	0077000960	3-1/2	0077001200	3-1/2	0077001450
2-3/4	0077000415	<b>LNG PART NUMBER</b>		<b>LNG = LENGTH</b>		<b>LNG = LENGTH</b>		4-1/4	0077000965	3-3/4	0077001205	3-3/4	0077001455
3-1/4	0077000425							4-1/2	0077000970	4-1/2	0077000970	4	0077001210
3-1/2	0077000430	4-3/4	0077000975	5	0077000980	5	0077000980	4-1/4	0077001215	4-1/4	0077001215	4-1/4	0077001465
3-3/4	0077000435	6	0077000980	5-1/4	0077000985	5-1/4	0077000985	4-1/2	0077001220	4-1/2	0077001220	4-1/2	0077001470
4	0077000440	6-1/2	0077001010	6-1/2	0077001010	6-1/2	0077001010	4-3/4	0077001225	5	0077001230	4-3/4	0077001475
<b>LNG PART NUMBER</b>		6-3/4	0077001015	6-3/4	0077001015	6-3/4	0077001015	5-1/4	0077001235	5-1/4	0077001235	5-1/4	0077001480
		7	0077001020	7	0077001020	7	0077001020	6	0077001240	6	0077001240	6	0077001485
<b>LNG PART NUMBER</b>		7	0077001020	<b>LNG PART NUMBER</b>		<b>LNG PART NUMBER</b>		6-1/4	0077001245	6-1/4	0077001245	6-1/4	0077001490
		7	0077001020					6-1/2	0077001250	6-1/2	0077001250	6-1/2	0077001255
<b>LNG PART NUMBER</b>		7	0077001020	<b>LNG PART NUMBER</b>		<b>LNG PART NUMBER</b>		6-3/4	0077001260	6-3/4	0077001260	6-3/4	0077001500
		7	0077001020					7	0077001270	7	0077001270	7	0077001270

# COTTER / DOWEL PINS / RIVETS WOODRUFF KEYS / RETAINING RINGS

THIS DOCUMENT IS PROTECTED BY COPYRIGHT. ALL RIGHTS ARE RESERVED. NO PART OF THIS DOCUMENT MAY BE PHOTOCOPIED, REPRODUCED, OR TRANSLATED TO ANOTHER LANGUAGE WITHOUT THE WRITTEN CONSENT OF ARROW INDUSTRIAL SUPPLY, INC. THE INFORMATION CONTAINED IN THIS DOCUMENT IS SUBJECT TO CHANGE WITHOUT NOTICE. COPYRIGHT 1993.

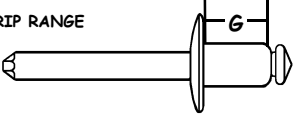
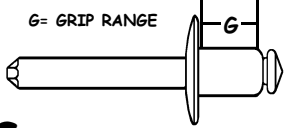
<b>BLIND RIVETS</b>			<b>DOMED HEAD</b>			<b>LARGE FLANGE RIVETS</b>								
														
ALUMINUM RIVET / ALUMINUM MANDREL			ALUMINUM RIVET / STEEL MANDREL			STEEL RIVET / STEEL MANDREL			STEEL RIVET / STEEL MANDREL			ALUMINUM RIVET / STEEL MANDREL		
1/8 DIA.			1/8 DIA.			1/8 DIA.			1/8 DIA.			1/8 DIA.		
GRIP	SZ	PART NUMBER	GRIP	SZ	PART NUMBER	GRIP	SZ	PART NUMBER	GRIP	SZ	PART NUMBER	GRIP	SZ	PART NUMBER
.020-.062	4-1	0007010500	.020-.062	4-1	0007010600	.020-.062	4-1	0007010650	.020-.125	4-2	0007010000	.020-.125	4-2	0007010030
.063-.125	4-2	0007010501	.063-.125	4-2	0007010601	.063-.125	4-2	0007010651	.126-.187	4-3	0007010001	.126-.187	4-3	0007010032
.126-.187	4-3	0007010502	.126-.187	4-3	0007010602	.188-.250	4-4	0007010653	.188-.250	4-4	0007010002	.188-.250	4-4	0007010033
.188-.250	4-4	0007010503	.188-.250	4-4	0007010603	.251-.312	4-5	0007010654	.251-.375	4-6	0007010003	.251-.375	4-6	0007010033
.313-.375	4-6	0007010504	.251-.312	4-5	0007010604	.313-.375	4-6	0007010655	.376-.500	4-8	0007010004	<b>3/16 DIA.</b>		
.376-.500	4-8	0007010505	.313-.375	4-6	0007010605	.376-.500	4-8	0007010656	.020-.250	6-4	0007010010	GRIP	SZ	PART NUMBER
<b>3/16 DIA.</b>			.376-.500	4-8	0007010606	<b>3/16 DIA.</b>			.251-.375	6-6	0007010012	.020-.250	6-4	0007010036
GRIP	SZ	PART NUMBER	.501-.625	4-10	0007010607	GRIP	SZ	PART NUMBER	.376-.500	6-8	0007010014	.251-.375	6-6	0007010038
.020-.125	6-2	0007010506	<b>3/16 DIA.</b>			.020-.125	6-2	0007010660	<b>1/4 DIA.</b>			.376-.500	6-8	0007010040
.188-.250	6-4	0007010507	GRIP	SZ	PART NUMBER	.188-.250	6-4	0007010662	.020-.250	8-4	0007010670	<b>ALUMINUM RIVET / ALUMINUM MANDREL</b>		
.251-.375	6-6	0007010508	.020-.125	6-2	0007010620	.251-.375	6-6	0007010663	.251-.375	8-6	0007010671	<b>1/8 DIA.</b>		
.376-.500	6-8	0007010509	.188-.250	6-4	0007010622	.376-.500	6-8	0007010664	.188-.250	4-4	0007010672	GRIP	SZ	PART NUMBER
<b>1/4 DIA.</b>			.376-.500	6-8	0007010624	.501-.625	6-10	0007010665	.251-.375	8-6	0007010673	.020-.125	4-2	0007010050
GRIP	SZ	PART NUMBER	.501-.625	6-10	0007010625	<b>1/4 DIA.</b>			.376-.500	8-8	0007010674	.188-.250	4-4	0007010052
.020-.250	8-4	0007010510	<b>1/4 DIA.</b>			GRIP	SZ	PART NUMBER	<b>3/16 DIA.</b>			.251-.375	4-6	0007010054
.251-.375	8-6	0007010511	GRIP	SZ	PART NUMBER	.020-.250	8-4	0007010670	GRIP	SZ	PART NUMBER	.020-.250	6-4	0007010058
.376-.500	8-8	0007010512	.020-.250	8-4	0007010630	.251-.375	8-6	0007010671	.251-.375	6-6	0007010059	.376-.500	6-8	0007010060
<b>1/4 DIA.</b>			.251-.375	8-6	0007010631	.376-.500	8-8	0007010672	<b>3/16 DIA.</b>			<b>3/16 DIA.</b>		
<b>1/4 DIA.</b>			.376-.500	8-8	0007010632	.501-.625	8-10	0007010673	.020-.250	6-4	0007010054	<b>3/16 DIA.</b>		
<b>1/4 DIA.</b>			.501-.625	8-10	0007010633	<b>1/4 DIA.</b>			.251-.375	6-6	0007010059	<b>3/16 DIA.</b>		
<b>1/4 DIA.</b>			<b>1/4 DIA.</b>			<b>1/4 DIA.</b>			.376-.500	6-8	0007010060	<b>3/16 DIA.</b>		

The material rivets are composed of varies. They are denoted by Rivet Material / Mandrel Material. Please check to ensure you order the right material as well as the right size.

